

PRODUCT INFORMATION PACKET



Model No: CI42D17FT1C

Catalog No: 098014.00

...25KW-1/3HP..1800RPM.71.IP54.180V...S1.40C.1.0SF.SPECIAL.CI42D17FT1C.....DC METRIC.....

Metric Motors



Regal and Leeson are trademarks of Regal Beloit Corporation or one of its affiliated companies.

©2018 Regal Beloit Corporation, All Rights Reserved. MC017097E





Nameplate Specifications

Output KW	0.37 kW	Voltage	180 V
Current	2.4 A	Speed	1800 rpm
Service Factor	1	Efficiency	78.5 %
Duty	S1	Insulation Class	F
Frame	71	Enclosure	IP54
Overload Protector	No	Ambient Temperature	40 °C
Drive End Bearing Size	6204	Opp Drive End Bearing Size	6203
UL	Recognized	CSA	Y
CE	Y		

Technical Specifications

Rotation	Reversible	Mounting	Special
Overall Length	11.28 in	Frame Length	6.50 in
Shaft Diameter	0.562 in	Shaft Extension	1.65 in
Outline Drawing	027543-098014		

This is an uncontrolled document once printed or downloaded and is subject to change without notice. Date Created: 10/15/2018

RBC PROPRIETARY AND CONFIDENTIAL INFORMATION
 This document is the property of REGAL BELOIT CORPORATION ("RBC") including its subsidiaries and divisions and contains proprietary information of RBC. This document is loaned on the express condition that neither it nor the information contained therein shall be disclosed to others without the express written consent of RBC, and that the information shall be used by the recipient only as approved expressly by RBC. This document shall be returned to RBC upon its request. This document may be subject to certain restrictions under U.S. export control laws and regulations.

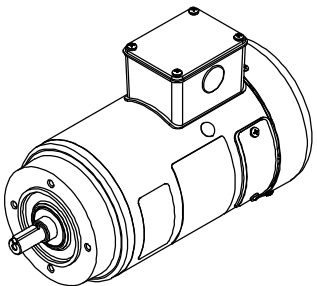
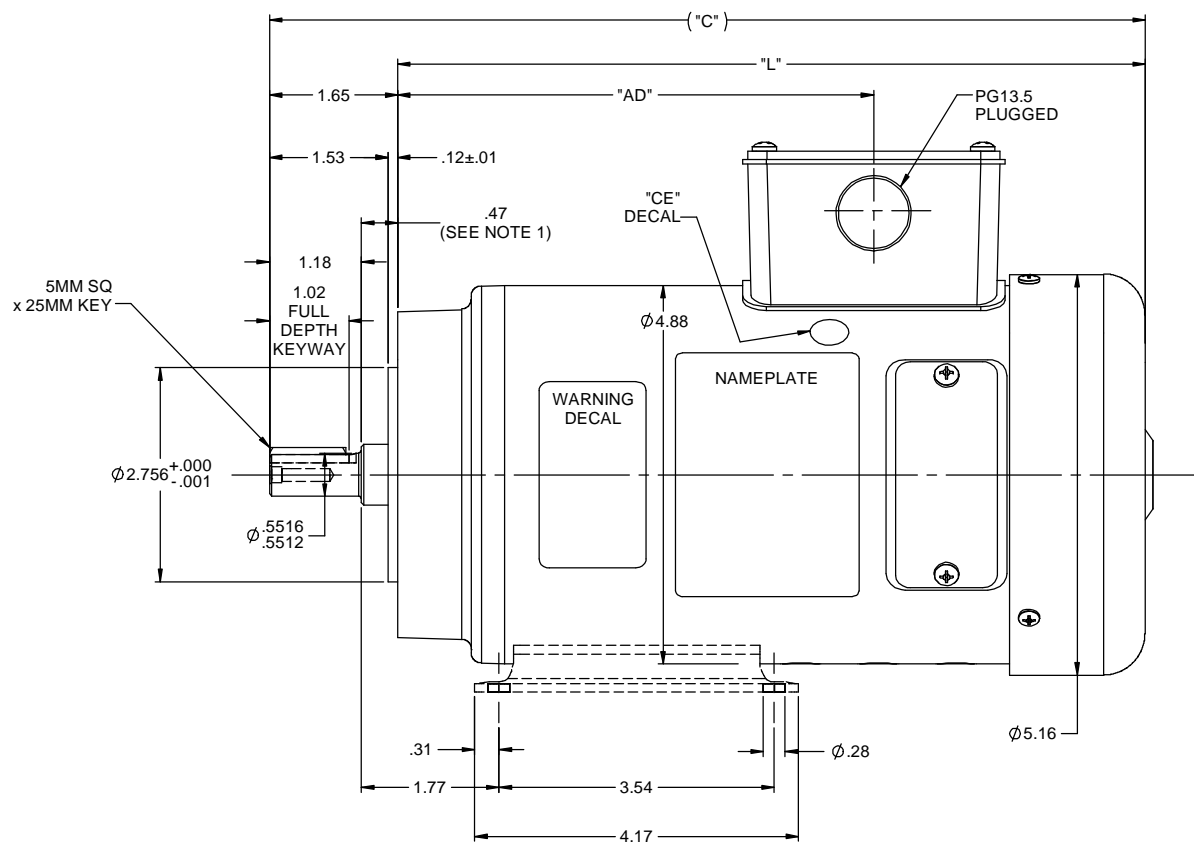
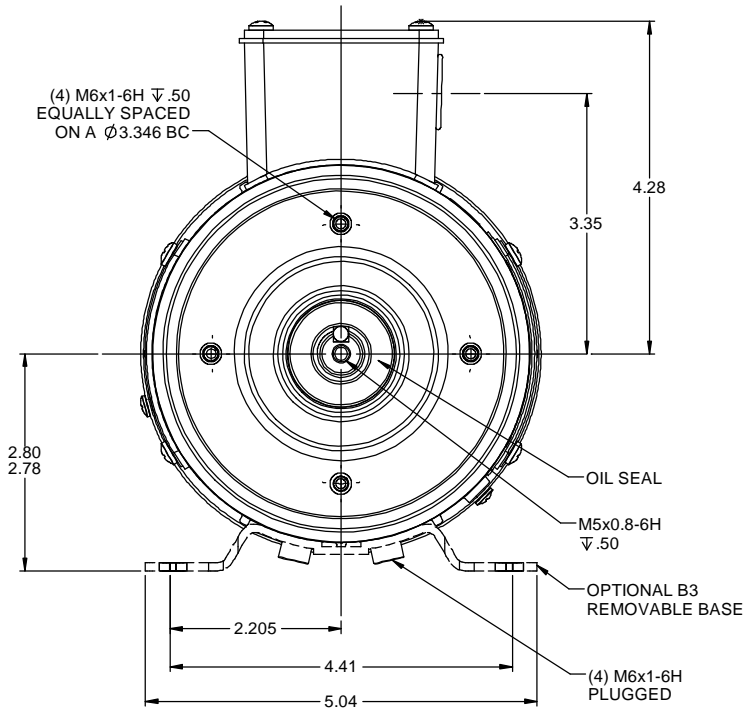

- NOTES:
 1) DIMENSION IS SPACE PROVIDED FOR A BOLT-ON B5 OR B14 ADAPTER KIT FOR THE IEC 71 FRAME.
 2) MAXIMUM FACE RUNOUT TO BE .004 T.I.R.
 3) MAXIMUM PILOT ECCENTRICITY .004 T.I.R.
 4) PERMISSIBLE SHAFT RUNOUT .002 T.I.R.
 5) GASKETS THROUGHOUT.

CATALOG No.	"C"	"L"	"AD"	VOLTS	K.W.	RPM
098014.00	11.28	9.63	6.13	180	.25	1800
098015.00	11.78	10.13	6.63	180	.37	1800
098016.00	10.78	9.13	5.63	180	.37	3000
098017.00	11.78	10.13	6.63	180	.55	3000

		TOLERANCES UNLESS SPECIFIED		LEESON ELECTRIC MOTORS GEARMOTORS AND DRIVES		DRAWN BJB 01/22/92	
		DEC	INCHES			CHK	
		X	±.1	TITLE OUTLINE 42 FRAME DC - IEC 71		APPR RPB 01/22/92	
		XX	±.03			SCALE 5:8	
--- REDRAWN IN SOLIDWORKS		IPG	2/20/12	XXX	±.005	REF	
05 CHANGED TO MYLAR NAMEPLATE PER ISAAC 08-24-11		RPB	12/17/08	BC	XXXX	±.0005	FMF
NO REVISION		BY & DATE	CHK	ANG	±1/2°	FINISH	PAGE OF
THIRD ANGLE PROJECTION		RFP		PREV		SIZE	DRAWING NO
		NETWORK FILE NAME 027543		B		027543	
						REV ---	